



STARK WIE EIN STIER

Kruhový svod odvodnění CAD detaily



OBSAH:

- 2 koleno Ø 60
- 3 koleno Ø 80
- 4 koleno Ø 100
- 5 koleno Ø 120
- 6 Soklové koleno
- 7 sběrný kotlík
- 8 Fasádní kotlík se zaústěním Ø 80 mm
- 9 Fasádní kotlík se zaústěním Ø 100 mm
- 10 Fasádní kotlík se zaústěním Ø 120 mm
- 11 Odbočka kruhového svodu 80
- 12 Odbočka kruhového svodu 100
- 13 Odbočka kruhového svodu 120



STARK WIE EIN STIER

koleno Ø 60 odvodnění CAD detaily

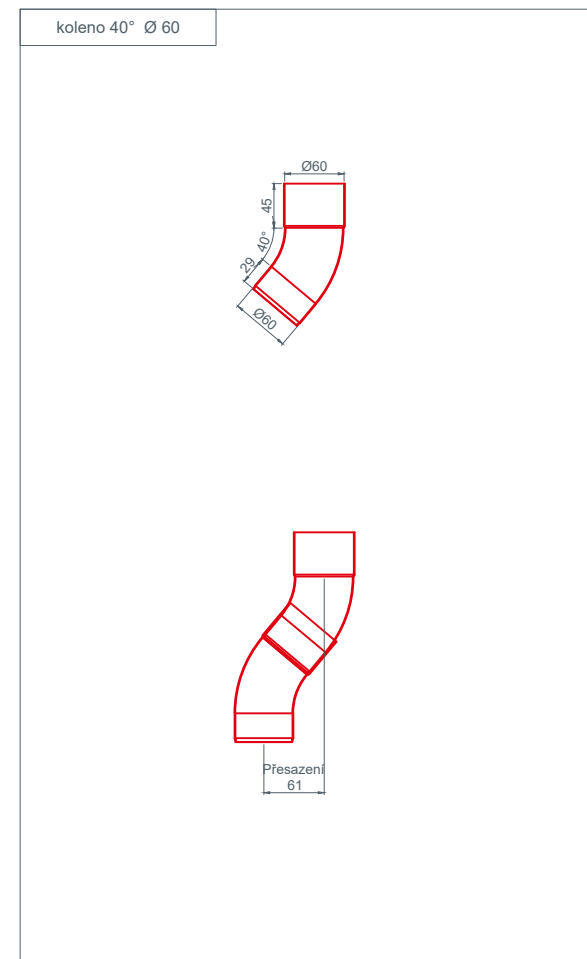
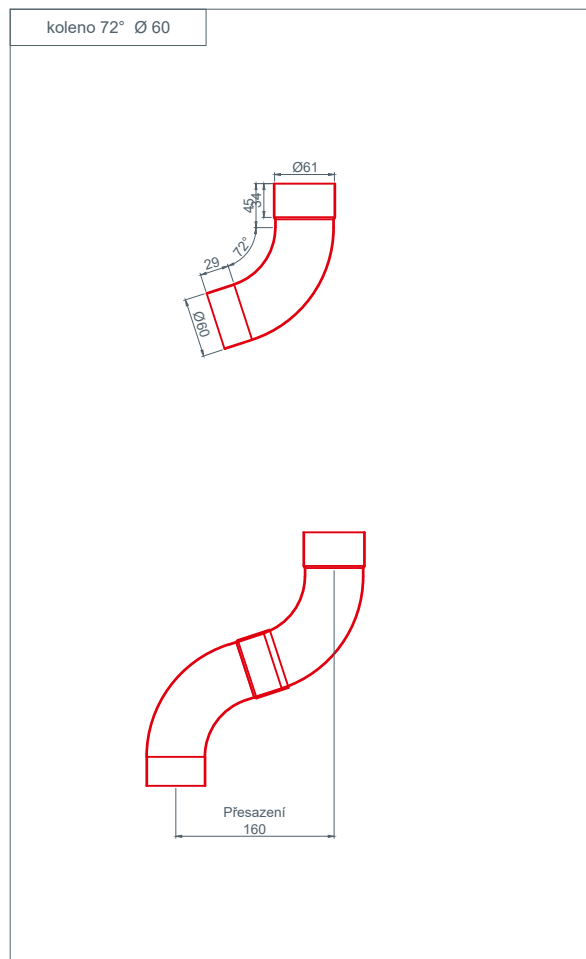
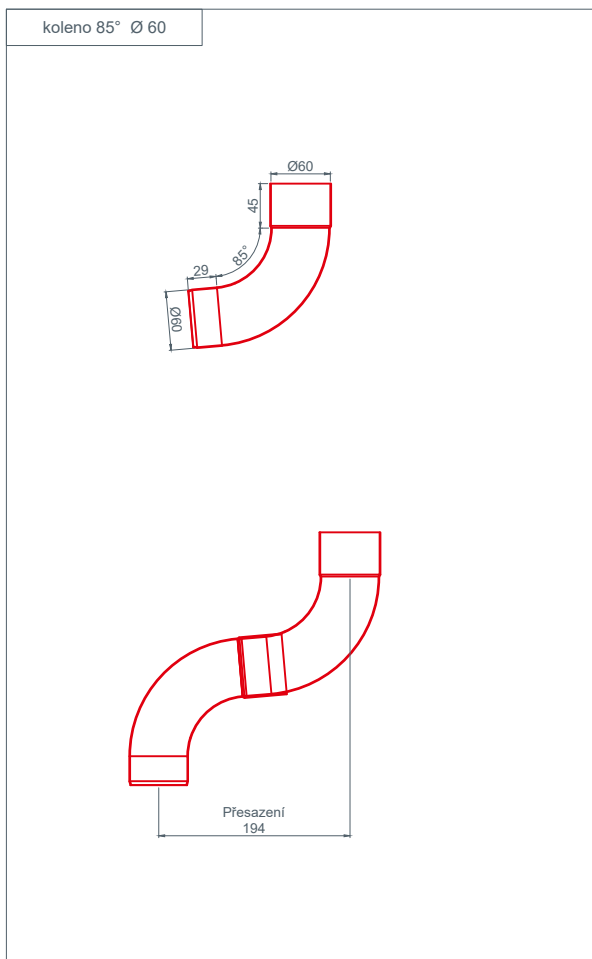



STARK WIE EIN STIER

koleno Ø 80 odvodnění CAD detaily

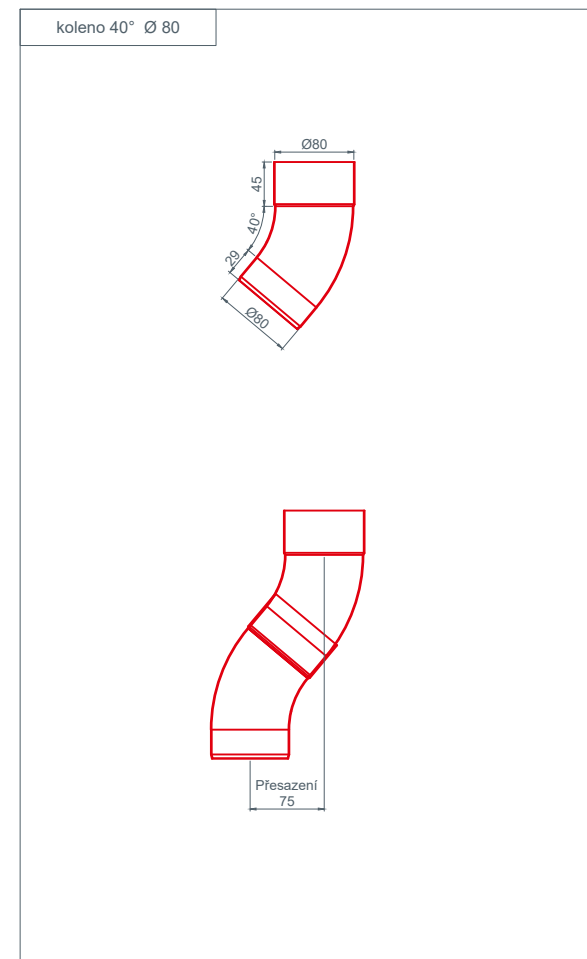
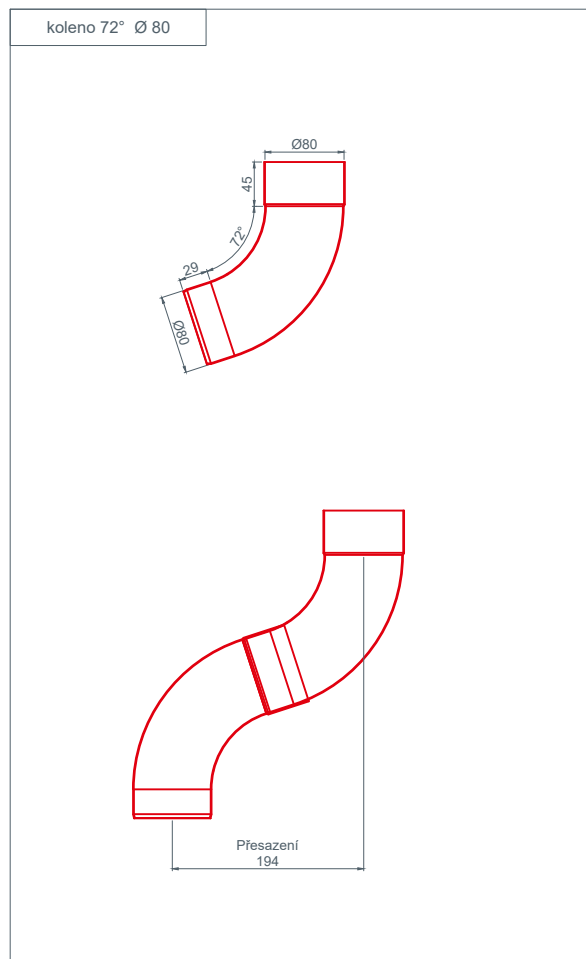
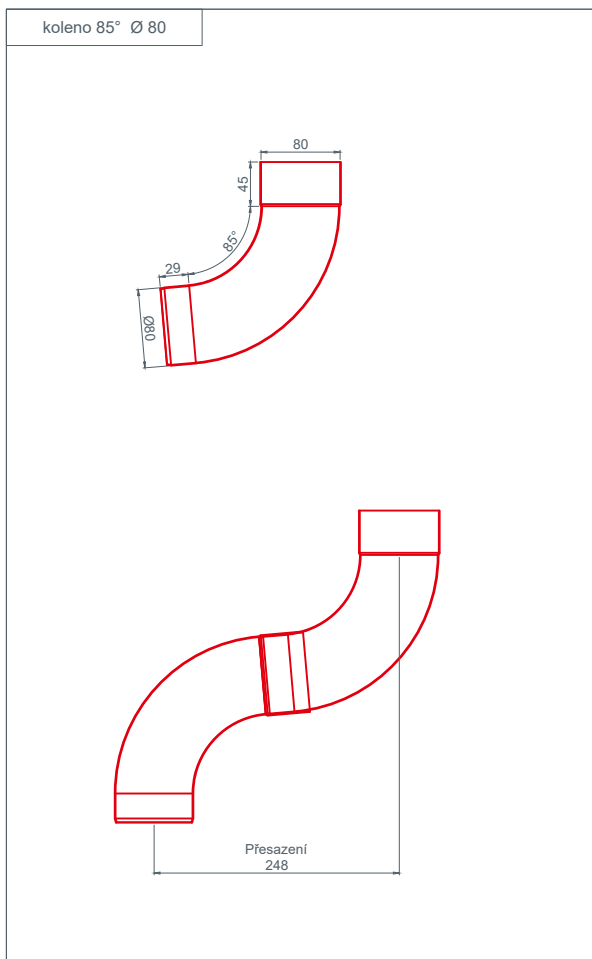



STARK WIE EIN STIER

koleno Ø 100 odvodnění CAD detaily

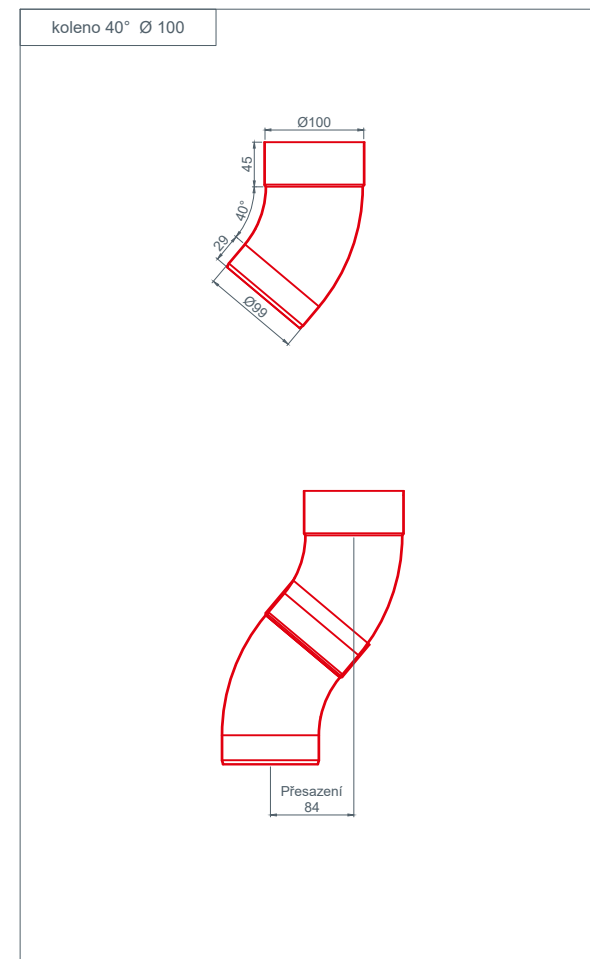
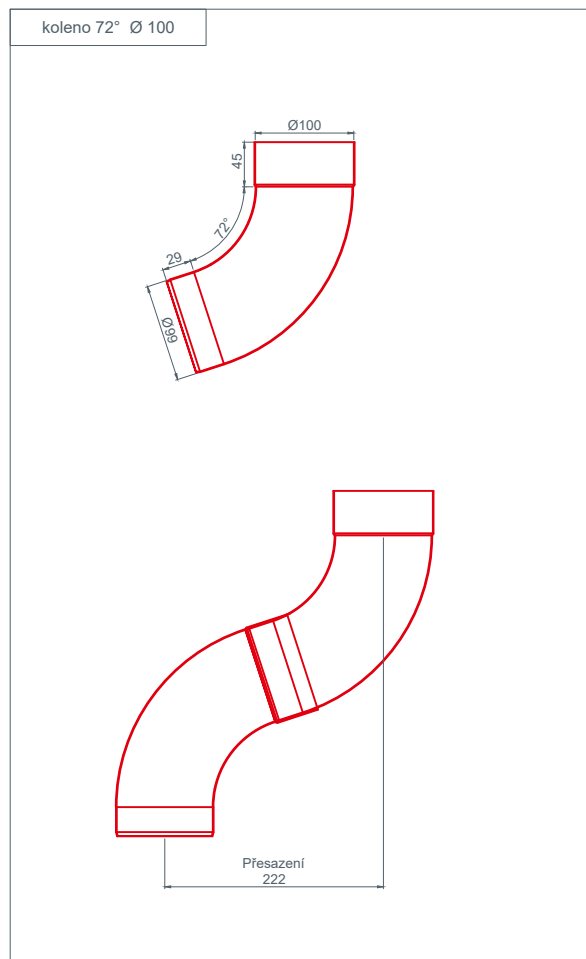
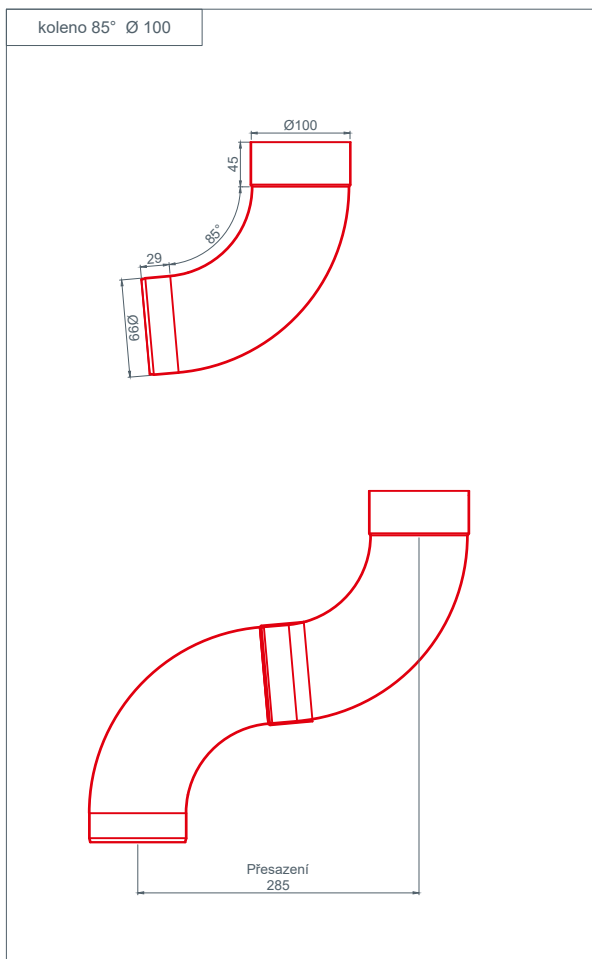



STARK WIE EIN STIER

koleno Ø 120 odvodnění CAD detaily

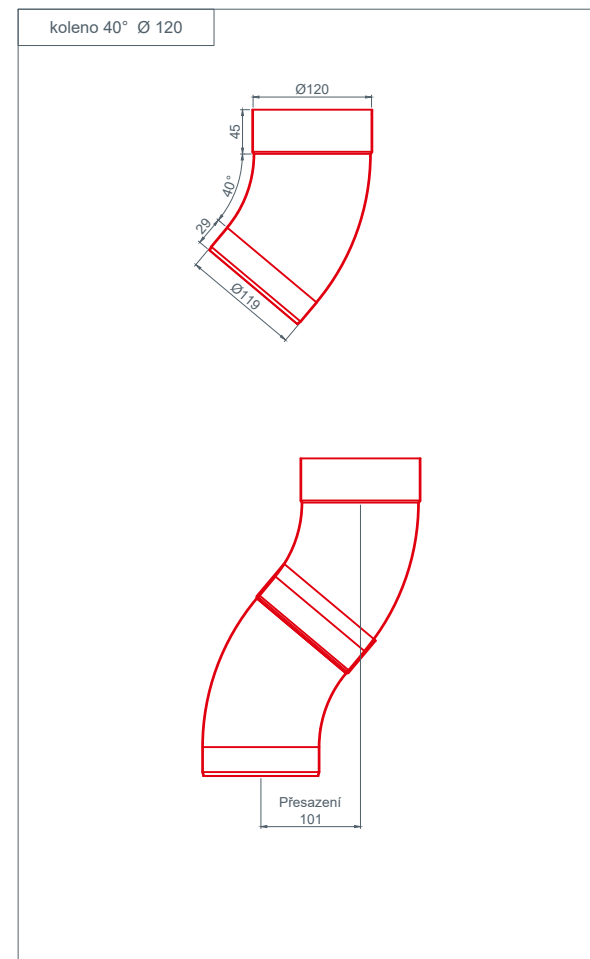
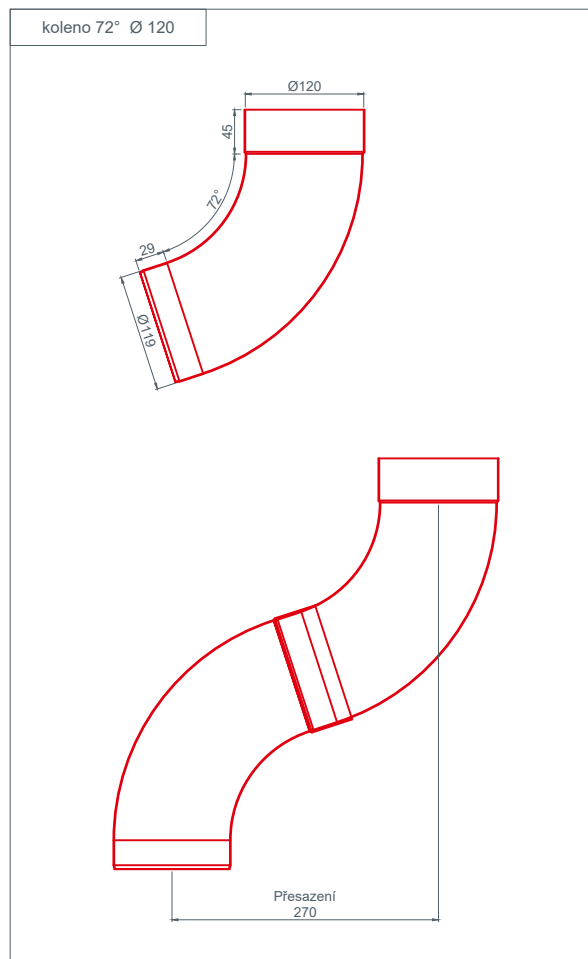
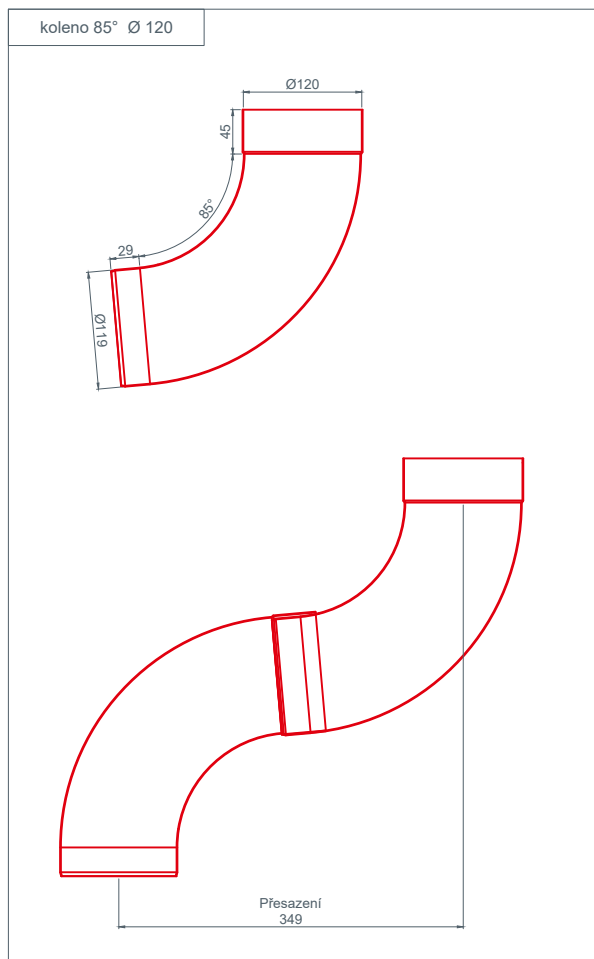



STARK WIE EIN STIER

Soklové koleno odvodnění CAD detaily

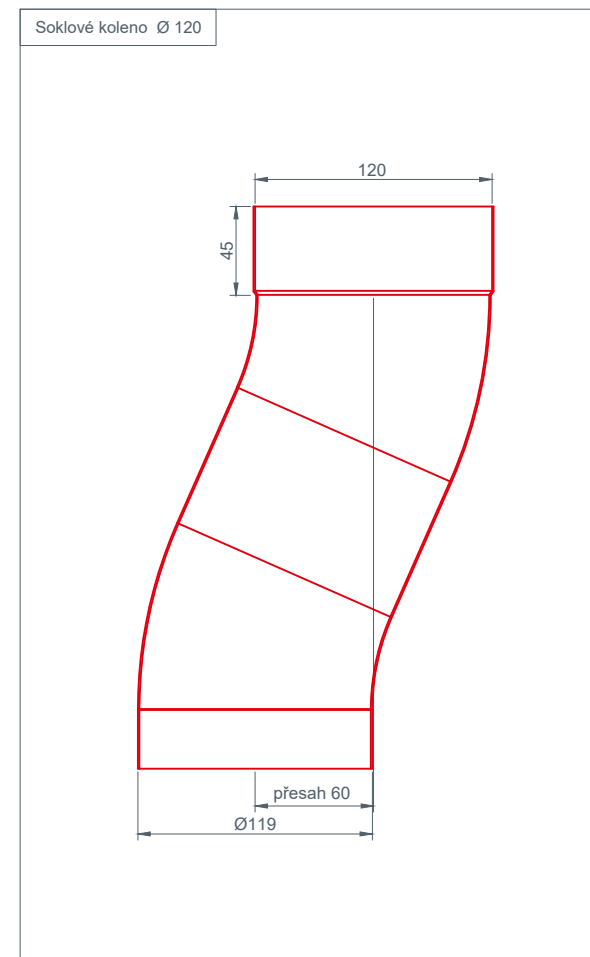
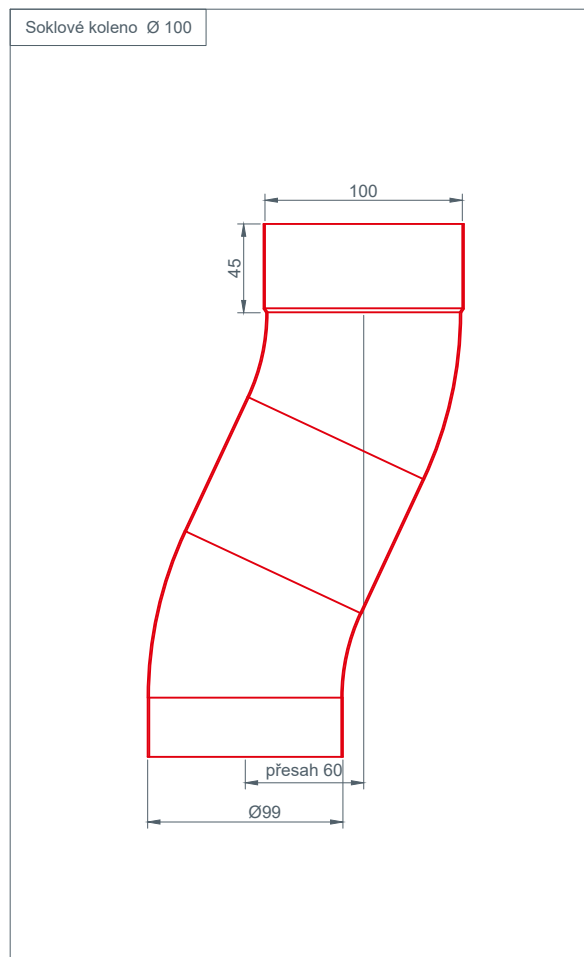
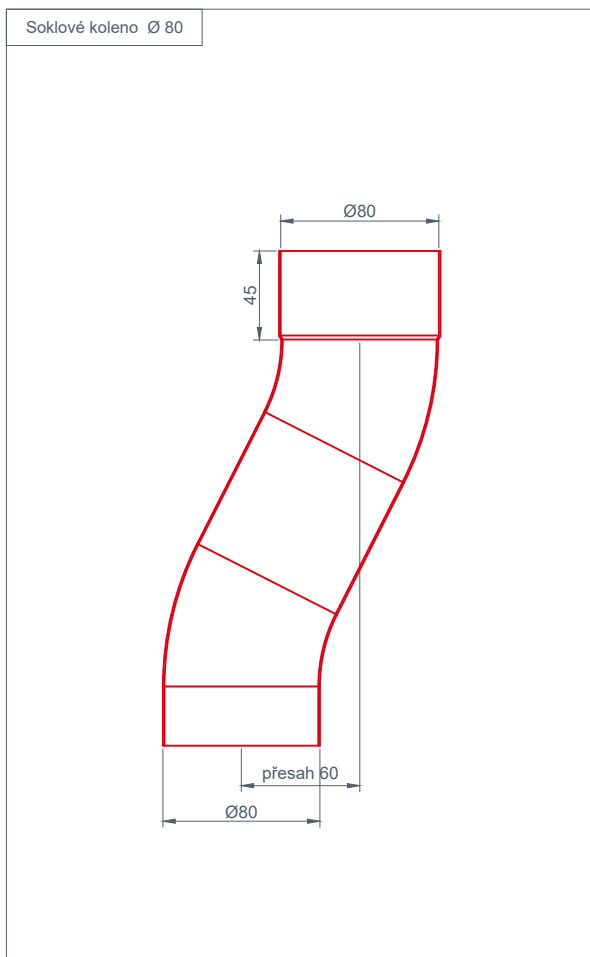



STARK WIE EIN STIER

sběrný kotlík odvodnění

CAD details

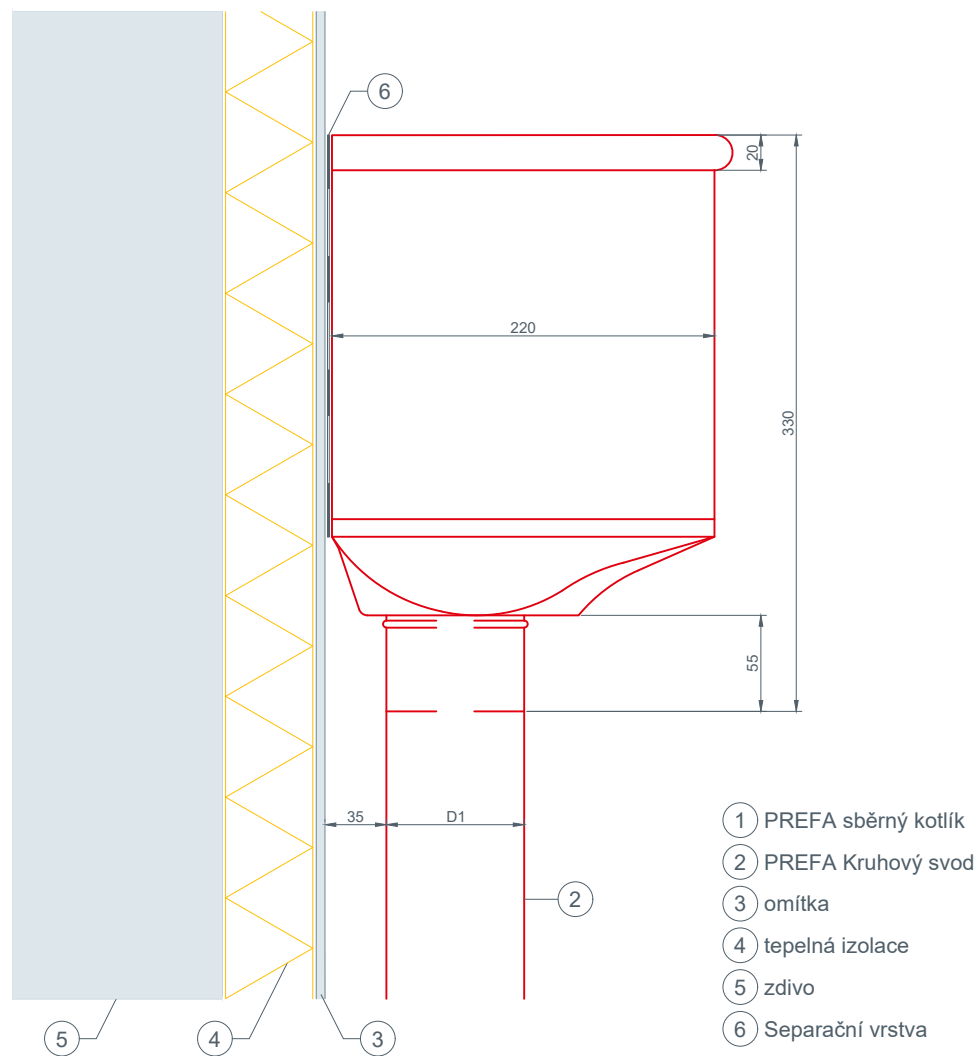

možné rozměry D1:

- Ø 80 mm
- Ø 100 mm
- Ø 120 mm



STARK WIE EIN STIER

Fasádní kotlík se zaústěním $\varnothing 80$ mm odvodnění CAD detaily

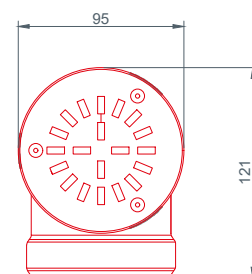
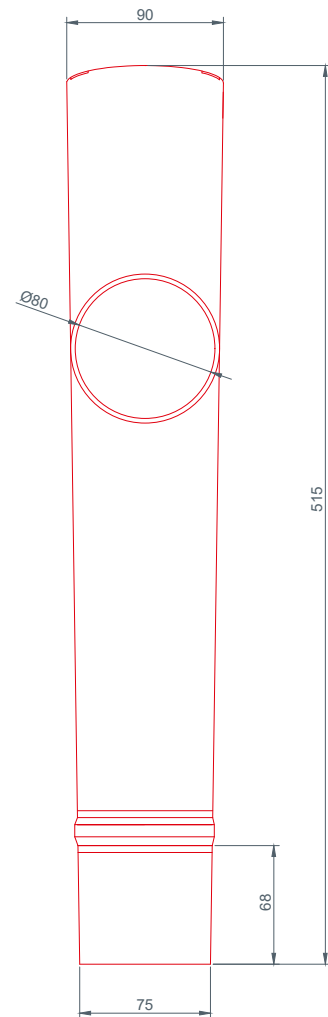
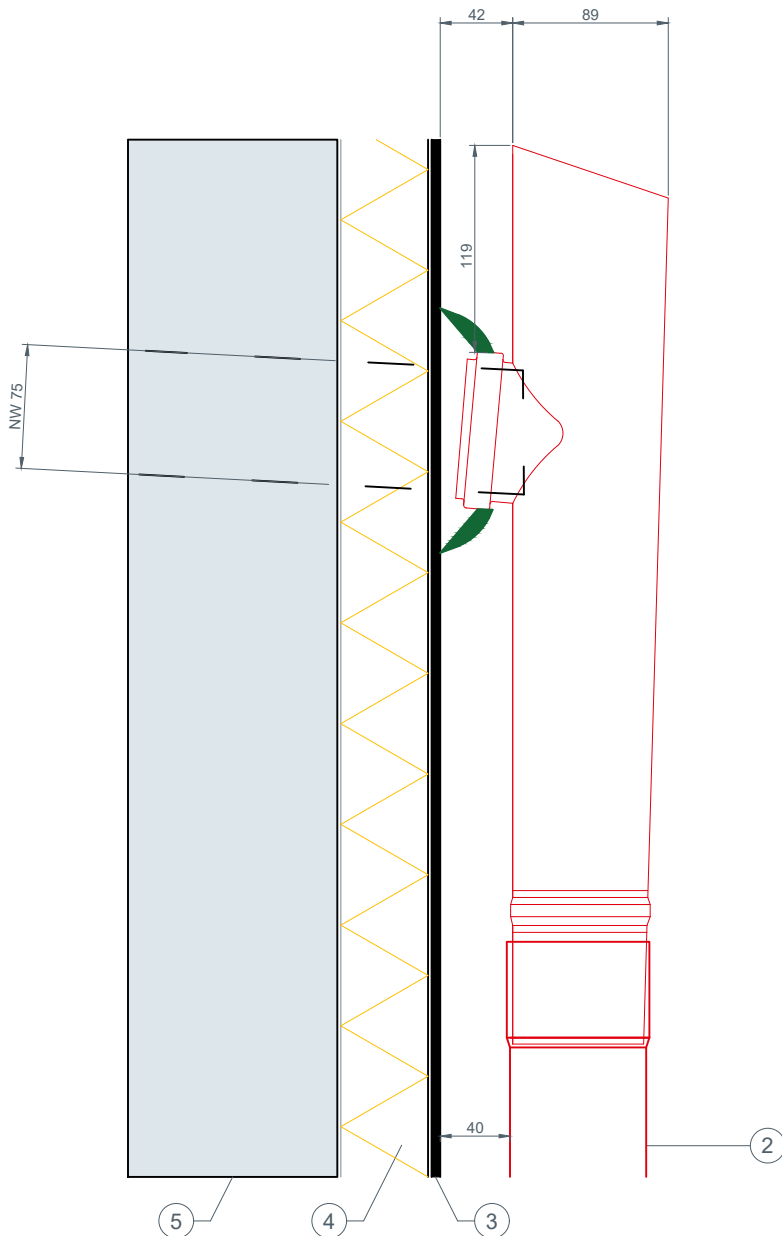

- ① PREFA Fasádní kotlík se zaústěním
- ② PREFA Kruhový svod
- ③ omítka
- ④ tepelná izolace
- ⑤ zdivo
- ⑥ EPDM těsnění



STARK WIE EIN STIER

Fasádní kotlík se zaústěním \varnothing 100 mm odvodnění CAD detaily

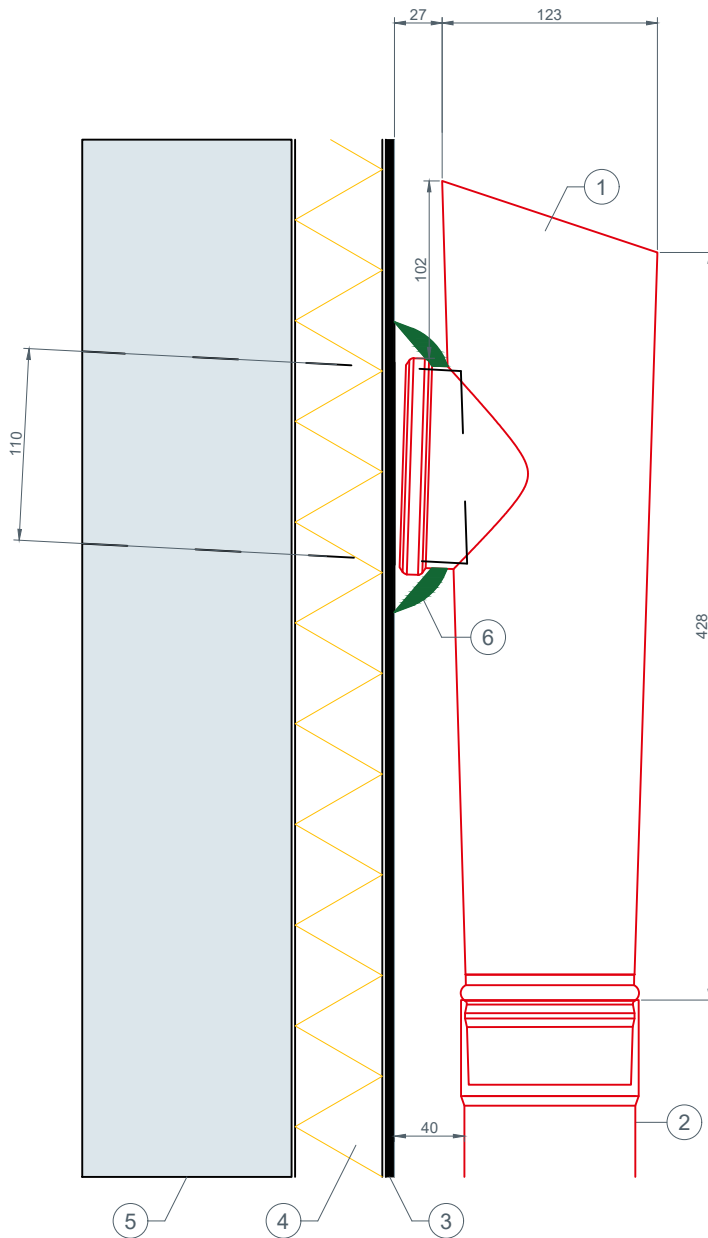

- ① PREFA Fasádní kotlík se zaústěním
- ② PREFA Kruhový svod
- ③ omítka
- ④ tepelná izolace
- ⑤ zdivo
- ⑥ EPDM těsnění



STARK WIE EIN STIER

Fasádní kotlík se zaústěním \varnothing 120 mm odvodnění CAD detaily

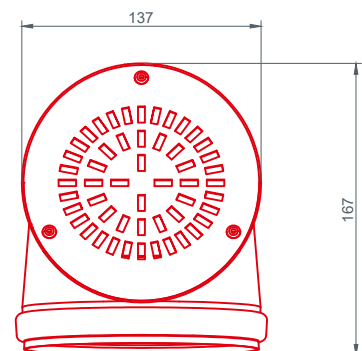
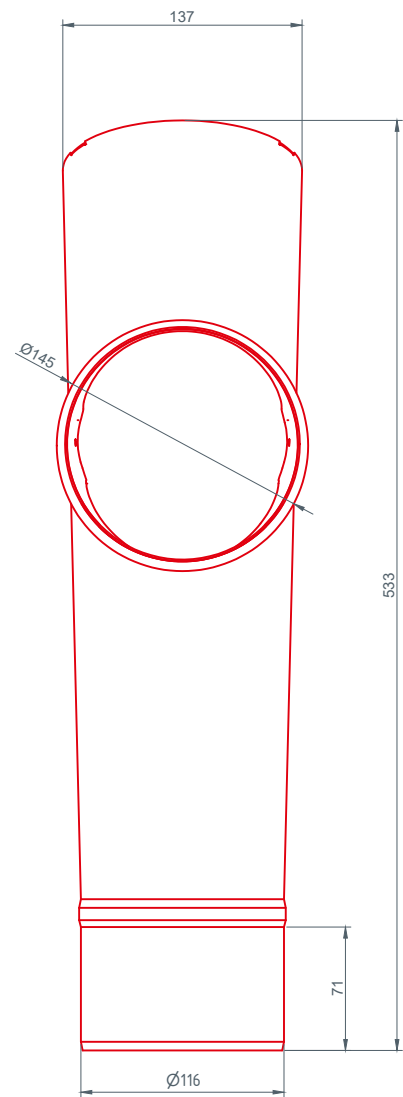
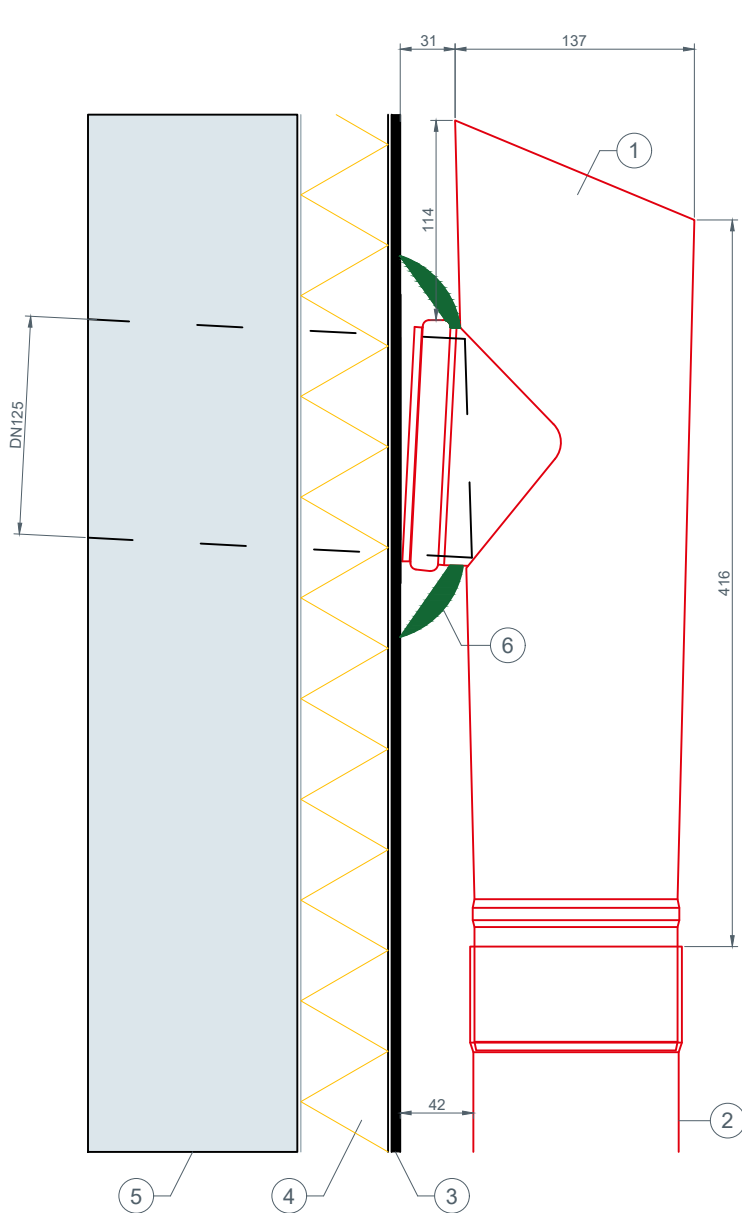

- ① PREFA Fasádní kotlík se zaústěním
- ② PREFA Kruhový svod
- ③ omítka
- ④ tepelná izolace
- ⑤ zdivo
- ⑥ EPDM těsnění



STARK WIE EIN STIER

Odbočka kruhového svodu 80

odvodnění

CAD detaily

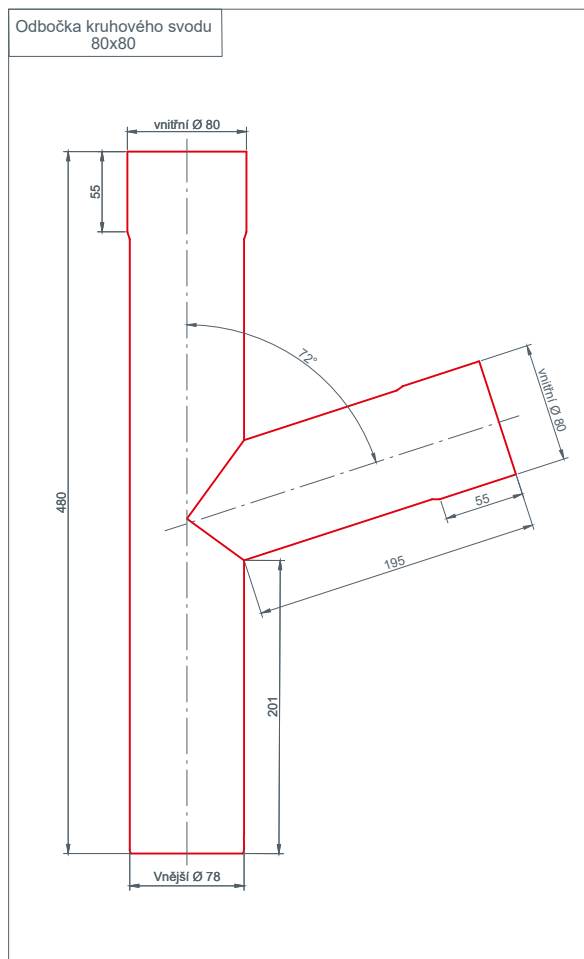
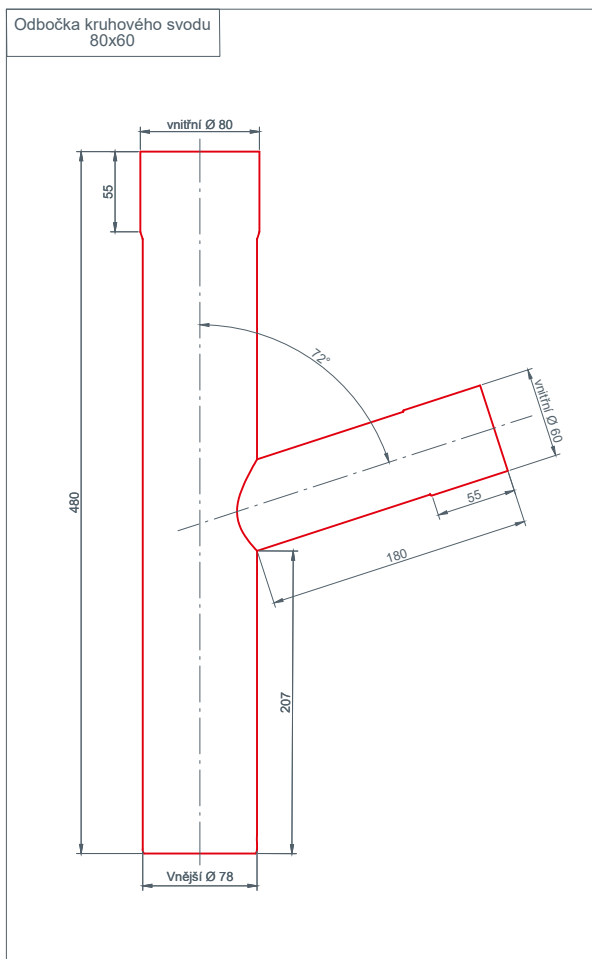



STARK WIE EIN STIER

Odbočka kruhového svodu 100 odvodnění CAD detaily

Odbočka kruhového svodu
100x60

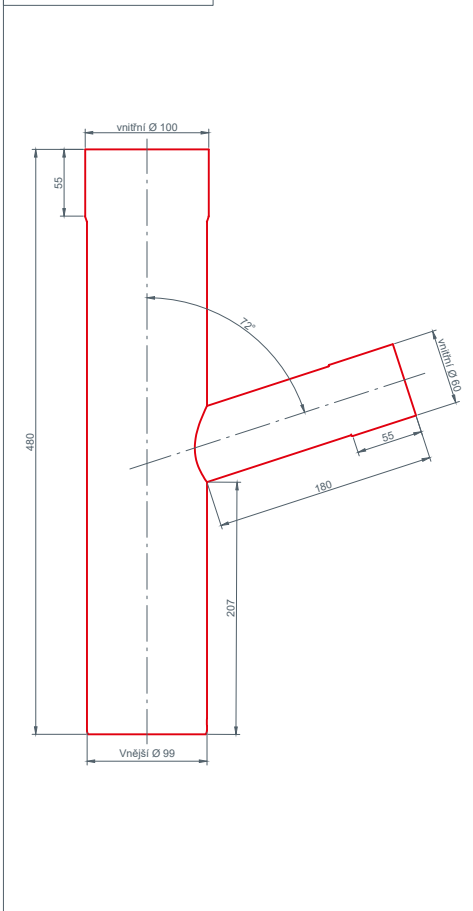

Odbočka kruhového svodu
100x80

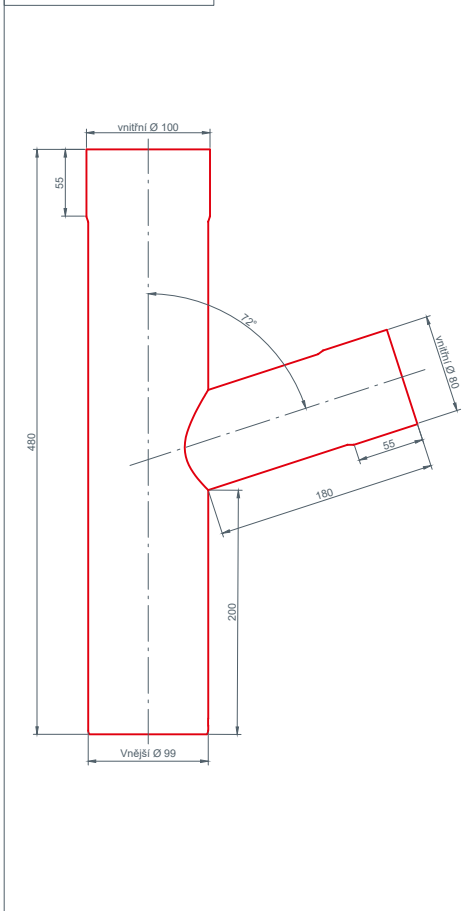

Odbočka kruhového svodu
100x100

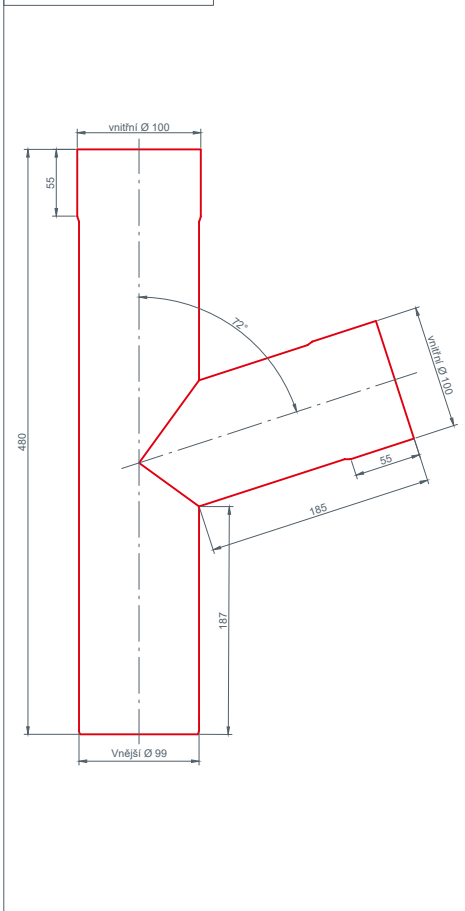

Odbočka kruhového svodu
100x50/75

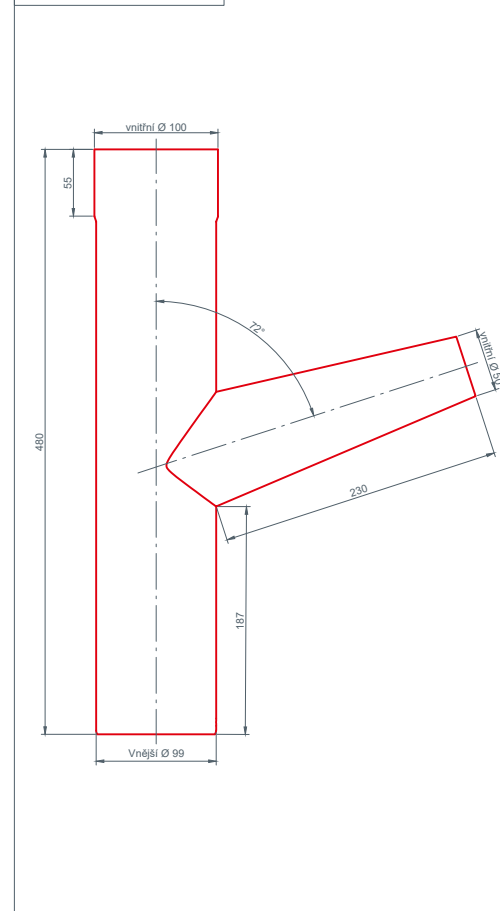



STARK WIE EIN STIER

Odbočka kruhového svodu 120 odvodnění CAD detaily

